

Pulse*LARSEN* *A n t e n n a s*

Amateur Antenna Products Volume 2

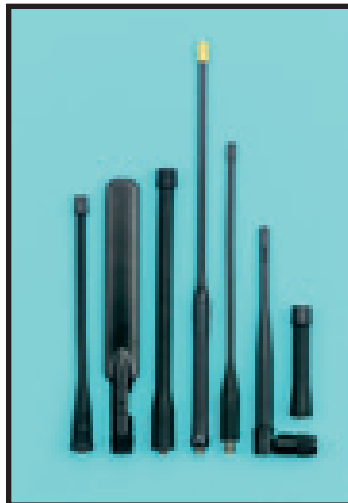

ISO 9001 Certified / RoHS Compliant

WELCOME

Larsen - a Pulse Brand - is pleased to bring you the new Amateur Catalog. The goal of the catalog is to provide you with a “go to” source for all your amateur needs. Here you will find our most popular Portable Radio, Low/Mid Band, VHF, UHF and small Base Station antennas along with the cable assemblies, mounting brackets, replacement parts and accessories to support them.

Larsen is a brand of Pulse Engineering. Headquartered in San Diego, California, Pulse is a worldwide leader in electronic component and subassembly design and manufacturing. Pulse is also a leading provider of antennas and antenna modules for mobile handsets and wireless devices. For more information on Pulse, please visit www.pulseeng.com.

Pulse provides a powerful synergy and new opportunities for customers, suppliers, employees, and channel partners. Customers can now source a diverse range of antennas from the combined antenna product lines. The Larsen brand also benefits from Pulse’s substantial engineering resources, including test equipment and anechoic chambers.

Your business is sincerely appreciated. We look forward to the opportunity to continue to serve your antenna requirements now and in the future.

CONTENTS

Technical Guide	4	VHF/UHF Wide Band Antennas	25
Glossary	6	Tunable 1/4 Wave Antennas	26
Portable Radio Antennas	8	Coaxial Cable	27
Mobile Antenna Placement	16	Cable Assemblies	28
28-136 MHz (VHF) Mobile Antennas	18	Small Base Station Antennas	34
136-174 MHz (UHF) Mobile Antennas	19	Replacement Parts/Accessories	36
220-225 MHz Mobile Antennas	21		
406-460 MHz (UHF) Mobile Antennas	22		

TECHNICAL GUIDE

FREQUENCY BANDS

Larsen amateur antennas are available in the following bands:

10m	28 - 30 MHz
6m	50 - 54 MHz
2m	144 - 148 MHz
1.25m	220 - 225 MHz
70cm	440 - 450 MHz
35cm	902 - 928 MHz

Not all antennas are available in all bands. Consult the product listings for specifications.

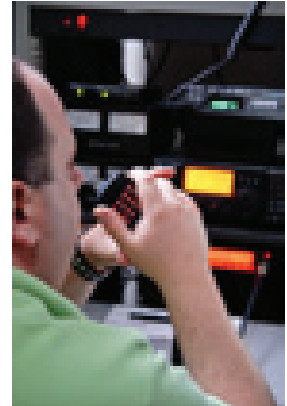

ELECTRICAL TYPES

Choosing the proper antenna for any application requires carefully weighing these criteria:

- Gain
- Physical Size
- Cost
- Appearance

The gain required depends on system margins and how far the system must operate. Generally, the more gain, the more cost and the longer the antenna. Systems where the antenna can be a low performance type will have less cost and less noticeable antennas at any particular frequency. Installations with a suitable ground plane will have the same performance at less cost than those without adequate ground plane.

To determine the best mobile antenna types to use in a particular installation, you should first be acquainted with all the electrical types available. Keep in mind not all types are available in all mechanical configurations and frequencies.

Loaded 1/4 Wave The loaded 1/4 wave antenna is electrically a 1/4 wave but is shorter than a full size 1/4 wave antenna. This is accomplished with a loading coil which places a portion of the electrical length of the antenna in a coil located at the base of the radiating element. The efficiency of the antenna depends on how much of the electrical length is inside the coil (and therefore not radiating). Typical gain is comparable to a full 1/4 wave where the full 1/4 wave is mounted on the fender and the loaded 1/4 wave is mounted on the roof. Typical length at the lowest recommended frequency is 49”.

1/4 Wave A single radiating element 1/4 wavelength long. It is the simplest and least expensive type of antenna. Length varies from 20” at 144 MHz to 3” at 900 MHz. A loading or matching coil is not required. Typical gain is unity when mounted on a suitable ground plane.

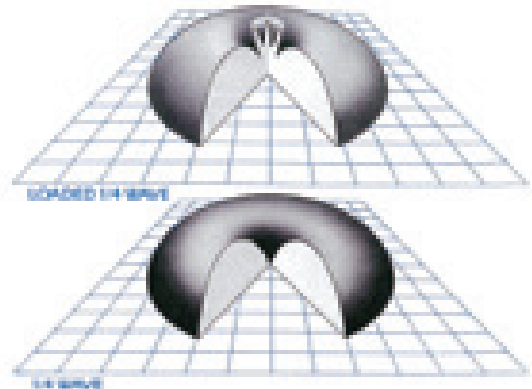

TECHNICAL GUIDE

1/2 Wave The 1/2 wave antenna is a single radiating element 1/2 wavelength long. Because the end fed impedance of the antenna is not suitable for matching the radio, an impedance matching transformer is used at the base of the radiating element. Length varies from 49" at 120 MHz to 13" at 440 MHz. The 1/2 wave antenna is suitable for use where no ground plane exists. The gain with no ground plane is unity. Gain with a suitable ground plane is 2.4 dBi.



5/8 Wave The 5/8 wave antenna is a single radiating element 5/8 wavelength long. In single element antennas, the 5/8 wave antenna has the best performance (3 dB) when mounted on a suitable ground plane. Element length varies from 49" at 144 MHz to 18" at 440 MHz. Since the end fed impedance of a 5/8 wave antenna is not suitable with a radio, an impedance transformer is used at the base of the rod. Must be mounted on a suitable ground plane.



Collinear Two elements separated by a phasing coil for increased gain. Three styles are common:

- 5/8 over 1/2 These collinear designs have two elements separated by a phasing coil. The top element is 5/8 wave and the bottom element is either a 1/2 wave or a 1/4 wave. Gain is typically 5 dB for a 1/2 wave lower element and 3-4 dB with a 1/4 wave lower element when mounted on a suitable ground plane. Antenna length is 23" to 29" at 440 MHz depending on the lower element. The end feed impedance matches the transmitter's impedance, so no transformer is used.
- 5/8 over 1/4
- 5/8 over 5/8 This collinear design has two elements separated by a phasing coil. Both top and bottom elements are 5/8 wave. Gain is typically 5 dB when mounted on a suitable ground plane. Collinear element length is 33" at 440 MHz. The end feed impedance does not match the transmitter's impedance, so a transformer is used

All Larsen antennas operate with a VSWR of 1.5 to 1 or less across the transmit bands.

GLOSSARY

Special model number designations, terms and abbreviations are used to facilitate quick identification and accurate ordering of Larsen products from this catalog.

B	Black whip when used after a “W” whip designation.
BA	Female to Female UHF connector with extra hardware useful in bulkhead mounting Larsen PO and MHW series antennas.
BASE	An antenna base which does not have a transformer or loading purpose. Its purpose is a mechanical one – to connect the whip to the mount.
BASE B	Indicates the color of base is black.
BCO	Indicates the product is a COIL only and the color of the coil is black.
BNC	Made to mount on BNC female or including BNC male connector.
BSAK	Base Station Adapter Kit. Makes a gain, ground plane antenna when used with Larsen Models PO150, NMO150 or NMO450. Complete with mounting hardware. No coax or connector supplied.
COIL	Denotes an impedance matching antenna coil or an antenna loading coil.
DS	Denotes mounting kit using dual shield RG-58A/U coax for lower loss and excellent flexibility.
FB1	Designates a 5/8 over 1/2 collinear ground plane base station antenna.
FB2	Designates a 5/8 over 1/4 collinear ground plane base station antenna.
HQ	Kūlduckie™ Portable Antenna with radiating element which is part helical and part 1/4 wave construction.
HW	HW indicates a design derived from a 1/2 wave. Used as a designation for both mobile and portable antennas.
K	Permanent mounting kit.
KD	Larsen Kūlduckie™ Antenna ... the successor to the “rubber ducky” for handheld and portables.
KG	Kūlglass™ glass-mount antenna series.
LM	Larsen Mount. Simplest and easiest to install. Only three parts. Requires 3/4” hole. Provides 5/16”-24 THDS stud to the antenna.
MHW	Mobile 1/2 wave antenna. Interfaces with any SO-239 type mount such as Larsen BSAK.

MM	Magnetic mount.
NMO	Fits Motorola TAD and TAE series mount and their 3/4" holes. "NMO" is used to create a family of compatible antennas, mounts, whips, etc. Model numbers that have NMO in them are compatible both mechanically and electrically.
NMOHF	Larsen NMOHF mount for frequencies from 27 MHz to 6 GHz. Pull the center pin to convert from low frequency to high frequency applications. Pulling the center pin creates a coax-type connection optimal for high frequency applications. The larger center contact pin provides for additional strength against downward compression during low frequency installations, resulting in better low frequency VSWR
NMOQ	1/4 wave whip antenna with a molded base to mate directly with Larsen NMO or NMOHF hardware.
OM	Larsen flange mount and antenna base in a single unit. Used on fiberglass tops, trucks, boats, farm machinery, etc. where conventional mounts present problems. Antenna requires no ground plane.
PHW	Portable 1/2 wave for emergency use with portables.
PL	PL-259 coax fitting complete with UG175 adapter where appropriate.
PO	Antenna series designed to fit onto SO-239 type UHF female connector for use on portables, utility stations or similar applications.
PQ	1/4 wave antenna mounted in PL-259 plug to fit portable equipment such as GE Portamobile, Motorola, etc.
Q	1/4 wave whip antenna with a threaded base fitting to fit 5/16"-24 THDS stud including GE, A/S and Larsen LM.
TMB	Trunk Mounting Bracket for car trunk gutter. Also denotes complete mounting kit.
W	Radiating element.
YA	Designates a Yagi antenna design. Different YA series (YA3, YA5, YA6) designates differences in elements, frequencies, gain, etc.

PORTABLE RADIO ANTENNAS

ELECTRICAL STYLES

To determine the best portable antenna to use in a particular application, you should first be acquainted with all the electrical styles available. Keep in mind not all types are available in all mechanical configurations and frequencies.

Helical

This most commonly used style is available in the widest range of frequencies — 136-221 MHz — and is carefully made for top performance. Helical antennas are wound with .050" steel wire and jacketed with copper plating for the best performance. Coverings include polyolefin for low dielectric loss and an outer wrap of PVC for good looks and rugged wear.

HQ Helical 1/4 Wave

For VHF applications requiring peak performance in the 144-148 MHz range while tolerating a length slightly longer than helical types. This unit provides an excellent compromise for many applications. It has a lower helical section with the upper element made from brass wound cable with a flexible shaft core to prevent breakage or brittleness. The HQ operates as a loaded 1/4 wave antenna.

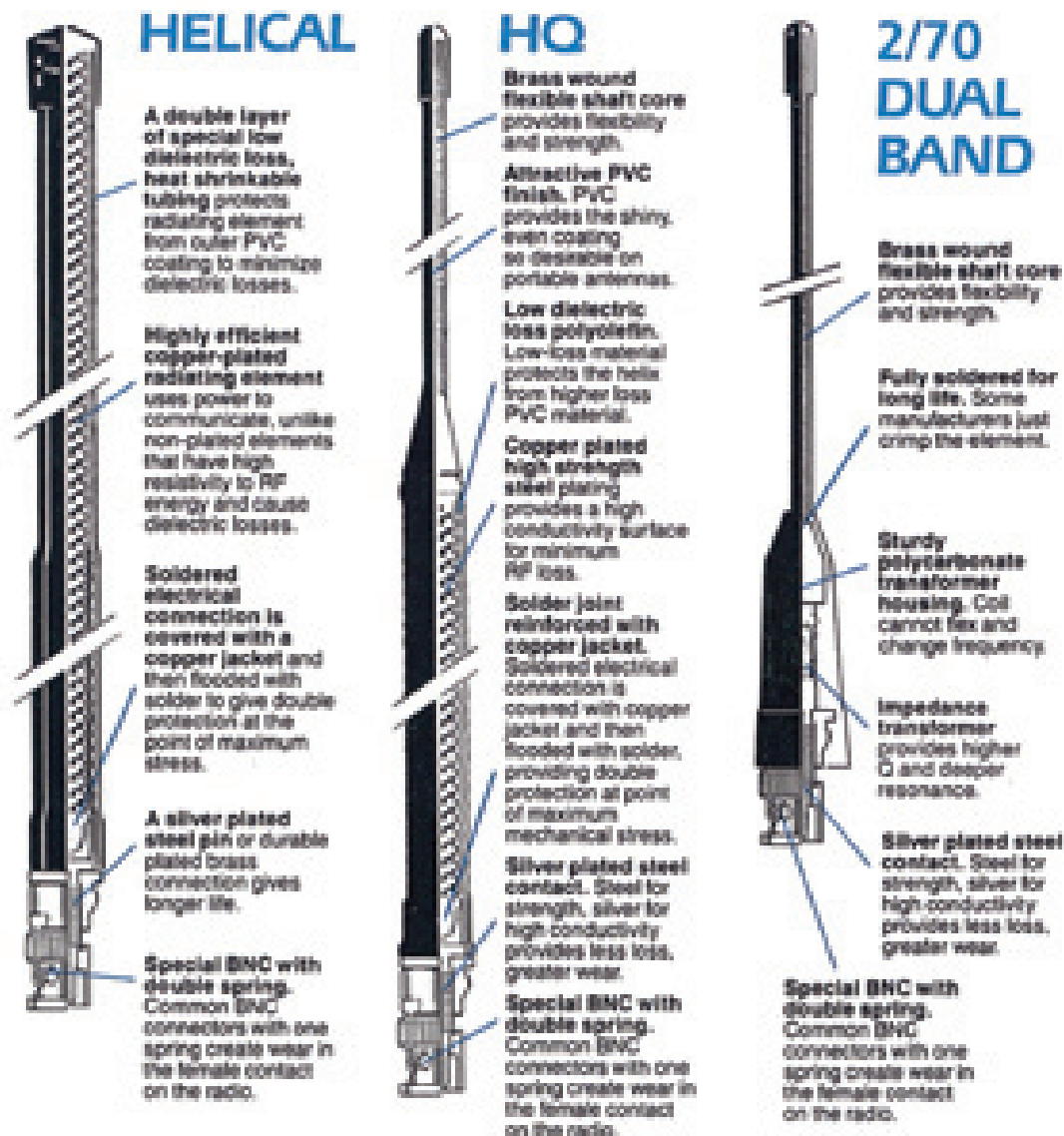

PORTABLE RADIO ANTENNAS

2/70 Dual Band

The 2/70 series Kùlduckie® portable antenna offers superb performance for dual band (2 meter / 70 centimeter) handheld radios. The antenna operates as a full 1/4 wave at 440-450 MHz and a loaded 1/4 wave at 144-148 MHz. Construction elements include a brass wound steel flexible core radiating element. The loading coil is housed in sturdy polycarbonate plastic for long life.

HW UHF 1/2 Wave

For UHF applications requiring maximum performance, the HW series is unmatched. It employs a resonant 1/2 wave design which allows it to operate independently of radio ground plane, and generates performance equal to a full 1/4 wave on a perfect ground plane. The rigid impedance transformer at the base contributes to optimum performance and adds extra strength. The HW-UHF model features a 1/2 wave whip with construction similar to the 1/4 wave model. The HW-UHF mounts with a BNC Male connector for easy on and off.

1/4 Wave

The full 1/4 wave style is a high performance antenna for UHF ranges of 440-450 MHz. It is constructed with a flexible steel core and electrically efficient brass wound cable. This special, flexible cable design assures excellence and durability under the most demanding conditions.

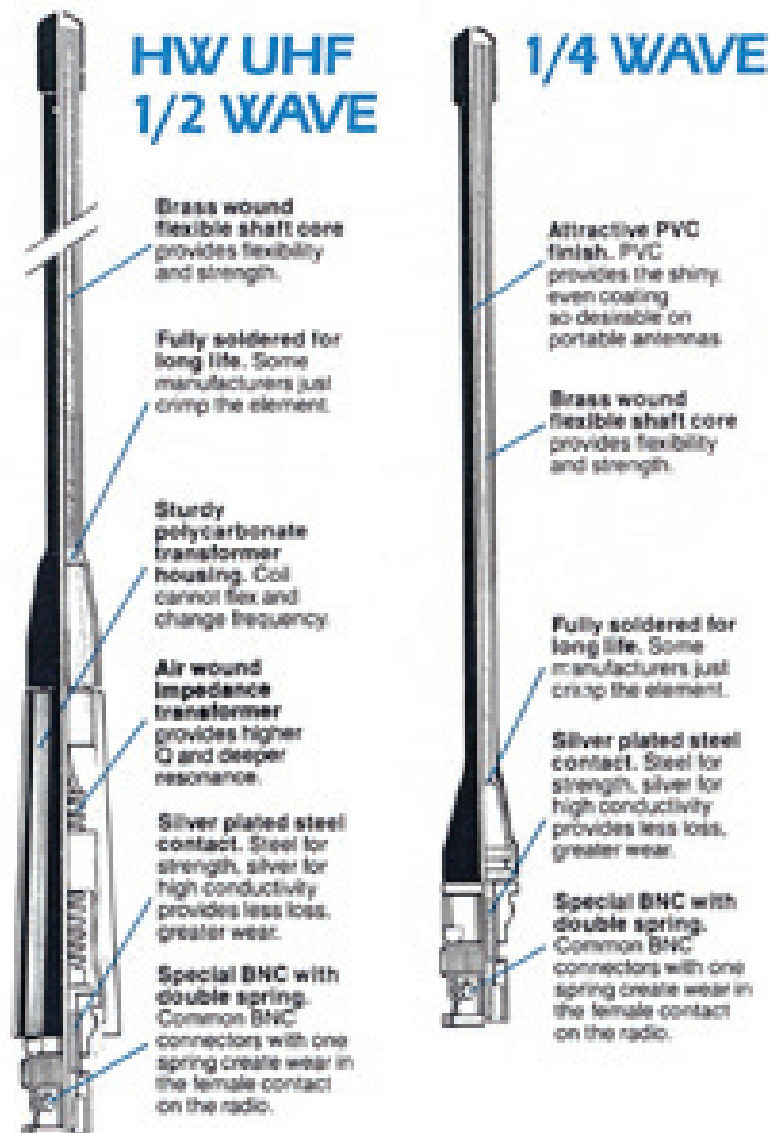

PORTABLE RADIO ANTENNAS

KULDUCKIE®

All factory tuned KūLDUCKIES® are ExacTuned to your specified frequency. To order, replace the FREQ, UHF or VHF designation with your desired center frequency.



1/4-32X3/16

Male stud type mount with skirt (MX type)
KD2/12

PART NUMBER	ELECTRICAL TYPE	FREQUENCY BAND	APPROX LENGTH
1/4-32x3/16			
KD2FREQHQ1	HQ Helical 1/4 λ	136 - 140 MHz	9 1/2"
KD2FREQHQ2	HQ Helical 1/4 λ	142 - 149 MHz	9 1/2"
KD2FREQHQ3	HQ Helical 1/4 λ	150 - 161 MHz	9 1/2"
KD2FREQHQ4	HQ Helical 1/4 λ	162 - 174 MHz	9 1/2"
KD12(freq)	1/4 λ	406 - 512 MHz	6"



TNC

TNC Male coaxial connector unskirted (TN type)
KD3/13

TNC MALE			
KD3FREQHQ1	HQ 1/4 λ	136 - 140 MHz	9 1/2"
KD3FREQHQ2	HQ Helical 1/4 λ	142 - 149 MHz	9 1/2"
KD3FREQHQ3	HQ Helical 1/4 λ	150 - 161 MHz	9 1/2"
KD3FREQHQ4	HQ Helical 1/4 λ	162 - 174 MHz	9 1/2"
KD13(freq)	1/4 λ	406 - 960 MHz	6"
TNCQ	Q 1/4 λ	136 - 512 MHz	Varies by freq

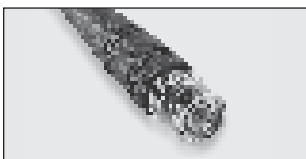

BNC

BNC Male coaxial connector unskirted
KD4/14

BNC MALE			
KD4UHF	Helical 1/4 λ	406 - 512 MHz	3"
KD4VHF1	Helical 1/4 λ	136 - 141 MHz	8"
KD4VHF2	Helical 1/4 λ	142 - 149 MHz	8"
KD4VHF3	Helical 1/4 λ	150 - 161 MHz	8"
KD4VHF4	Helical 1/4 λ	162 - 174 MHz	8"
KD4FREQHQ1	HQ Helical 1/4 λ	136 - 140 MHz	9 1/2"
KD4FREQHQ2	HQ Helical 1/4 λ	142 - 149 MHz	9 1/2"
KD4FREQHQ3	HQ Helical 1/4 λ	150 - 161 MHz	9 1/2"
KD4FREQHQ4	HQ Helical 1/4 λ	162 - 174 MHz	9 1/2"
KD4150T	Helical 1/4 λ	130 - 180 MHz	Varies by freq
KD14(freq)	1/4 λ	406 - 960 MHz	6"
KD14FREQHW1	HW UHF 1/2 λ	315 - 409 MHz	16 1/2"
KD14FREQHW2	HW UHF 1/2 λ	416 - 504 MHz	16 1/2"
BNCQ	Q 1/4 λ	136 - 512 MHz	Varies by freq

PORTABLE RADIO ANTENNAS

KULDUCKIE®

PART NUMBER	ELECTRICAL TYPE	FREQUENCY BAND	APPROX LENGTH
5/16-32X3/8			
KD7FREQHQ1	HQ 1/4 λ	136 - 140 MHz	9 1/2"
KD7FREQHQ2	HQ 1/4 λ	142 - 149 MHz	9 1/2"
KD7FREQHQ3	HQ 1/4 λ	150 - 161 MHz	9 1/2"
KD7FREQHQ4	HQ 1/4 λ	162 - 174 MHz	9 1/2"



5/16-32X3/8

Male stud type mount (KR type)
KD7

PL-259			
KD9FREQHQ1	HQ 1/4 λ	136 - 140 MHz	9 1/2"
KD9FREQHQ2	HQ 1/4 λ	142 - 149 MHz	9 1/2"
KD9FREQHQ3	HQ 1/4 λ	150 - 161 MHz	9 1/2"
KD9FREQHQ4	HQ 1/4 λ	162 - 174 MHz	9 1/2"
KD19(freq)	1/4 λ	406 - 512 MHz	6"
PQ	Q 1/4 λ	144 - 512 MHz	Varies by freq



PL-259

Standard UHF Connector Male
KD9/19

5/16-24 THDS Female			
KD22VHF1	Helical 1/4 λ	136 - 141 MHz	8"
KD22VHF2	Helical 1/4 λ	142 - 149 MHz	8"
KD22VHF3	Helical 1/4 λ	150 - 161 MHz	8"
KD22VHF4	Helical 1/4 λ	162 - 174 MHz	8"
KD22FREQHQ1	HQ Helical 1/4 λ	136 - 140 MHz	9 1/2"
KD22FREQHQ2	HQ Helical 1/4 λ	142 - 149 MHz	9 1/2"
KD22FREQHQ3	HQ Helical 1/4 λ	150 - 161 MHz	9 1/2"
KD22FREQHQ4	HQ Helical 1/4 λ	162 - 174 MHz	9 1/2"



5/16-24THDS Female

Female threaded
KD22

PORTABLE RADIO ANTENNAS

SPOTS!

DECODING SPOTS! PART NUMBERS

Typical part number: SPHL10144

SP
SPOTS!
Product Line

HL
Helical
Antenna Type

10
Connector
Number

144
Center Cut
Frequency

CODE	ANTENNA TYPE
HL	Helical Type - Standard
HS	Helical Type - Short
WH	Whip
EN	End Fed 1/2 Wave
DA	1/2 Wave Dipole with Articulated Right Angle Connector
DP	1/2 Wave Dipole
WB	Wide Band

SPOTS! ANTENNA SELECTION GUIDE BY CONNECTOR TYPE

Determine connector type and select the proper ANTENNA based on frequency and type below. Field tunable antennas come with a cutting chart and cap to allow for tuning to exact frequency.

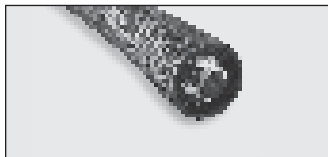

1/4-32X3/16

Male stud type mount with skirt (MX type)
SPOTS! Connector Code 10

1/4-32X3/16 - MALE STUD CONNECTOR (MX TYPE)

CODE 10

PART NUMBER	FREQUENCY BAND (MHZ)	ANTENNA TYPE	APPROX LENGTH
SPHL10156	150 - 162	Helical Standard 1/4 λ	8"
SPHS10156	152 - 160	Helical Short 1/4 λ	4"
SPHL10160	154 - 166	Helical Standard - 1/4 λ	8"
SPHL10160IC**	CC to 157	Helical Standard 1/4 λ	8"
SPHL10167	160 - 174	Helical Standard 1/4 λ	8"
SPHL10167IC**	CC to 167	Helical Standard 1/4 λ	8"
SPWH10420	395 - 445	Whip Standard 1/4 λ	6"
SPHS10420	403 - 437	Helical Short 1/4 λ	3"
SPWH10450	425 - 475	Whip Standard 1/4 λ	6"
SPHS10450	432 - 468	Helical Short 1/4 λ	3"
SPWH10470	450 - 490	Whip Standard 1/4 λ	6"
SPHS10470	452 - 488	Helical Short 1/4 λ	3"
SPHL10FT	Field Tunable 136 - 221	Helical Standard 1/4 λ	8"

** This antenna is designed with a longer "skirt" for use with newer ICOM radios.

PORTABLE RADIO ANTENNAS

SPOTS!

M7 X 1.00 METRIC CONNECTOR (MD TYPE)

CODE 14

PART NUMBER	FREQUENCY BAND (MHZ)	ANTENNA TYPE	APPROX LENGTH
SPHL14FT	Field Tunable 136 - 221	Helical - Standard - $1/4 \lambda$	7"

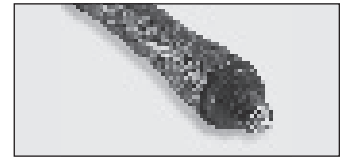

M7.0X1.0

Male stud type connector unskirted (MD type)

SPOTS! Connector Code 14

BNC CONNECTOR (BN TYPE)

CODE 15

PART NUMBER	FREQUENCY BAND (MHZ)	ANTENNA TYPE	APPROX LENGTH
SPHS15450	432 - 468	Helical - Short - $1/4 \lambda$	3"
SPHL15FT	Field Tunable 136 - 221	Helical - Standard - $1/4 \lambda$	8"
SPWH15FT	Field Tunable 400 - 512	Whip - Standard - $1/4 \lambda$	6"



BNC

BNC Male coaxial connector unskirted

SPOTS! Connector Code 15

BNC CONNECTOR COVERED TYPE (BNX TYPE)

CODE 16

PART NUMBER	FREQUENCY BAND (MHZ)	ANTENNA TYPE	APPROX LENGTH
SPHL16FT	Field Tunable 136 - 221	Helical - Standard - $1/4 \lambda$	8"
SPWH16FT	Field Tunable 400 - 512	Whip - Standard - $1/4 \lambda$	6"

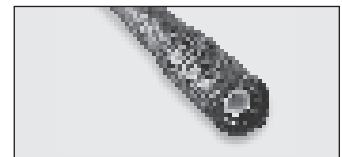

BNC-S

BNC Male coaxial connector fully skirted (BNX type)

SPOTS! Connector Code 16

TNC CONNECTOR - STANDARD (TN TYPE)

CODE 17

PART NUMBER	FREQUENCY BAND (MHZ)	ANTENNA TYPE	APPROX LENGTH
SPHL17FT	Field Tunable 136 - 221	Helical - Standard - $1/4 \lambda$	8"
SPWH17FT	Field Tunable 400 - 512	Whip - Standard - $1/4 \lambda$	6"

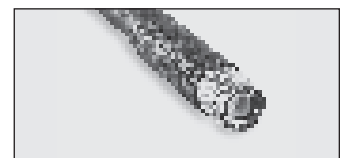

TNC

TNC Male coaxial connector unskirted (TN type)

SPOTS! Connector Code 17

PORTABLE RADIO ANTENNAS

SPOTS!

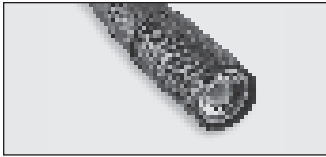

TNC-S

TNC Coaxial connector fully skirted (TNX type)
SPOTS! Connector Code 18

TNC CONNECTOR - COVERED (TNX TYPE)

CODE 18

PART NUMBER	FREQUENCY BAND (MHZ)	ANTENNA TYPE	APPROX LENGTH
SPHL18FT	Field Tunable 136 - 221	Helical - Standard - 1/4 λ	8"
SPWH18FT	Field Tunable 400 - 512	Whip - Standard - 1/4 λ	6"



SMA MALE T1

SMA Male extended base (SMS Type)
SPOTS! Connector Code 20

SMA MALE STANDARD - EXTENDED BASE - T1 (SMS TYPE)

CODE 20

PART NUMBER	FREQUENCY BAND (MHZ)	ANTENNA TYPE	APPROX LENGTH
SPHL20FT	Field Tunable 136 - 221	Helical - Standard - 1/4 λ	8"
SPWH20FT	Field Tunable 400 - 512	Whip - Standard - 1/4 λ	6"

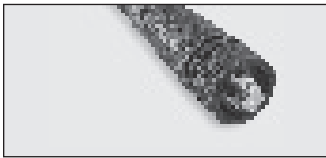

SMA F T1

SMA Female flush insulator & partial skirt (SF Type)
SPOTS! Connector Code 21

SMA FEMALE - NON STANDARD MOTOROLA TYPE (SF TYPE)

CODE 21

PART NUMBER	FREQUENCY BAND (MHZ)	ANTENNA TYPE	APPROX LENGTH
SPWB21150	136 - 174	Helical - Standard - 1/4 λ	6.75"
SPHL21156	150 - 162	Helical - Standard - 1/4 λ	8"
SPHS21156	152 - 160	Helical - Short - 1/4 λ	4"
SPHL21167	160 - 174	Helical - Standard - 1/4 λ	8"
SPHS21167	162 - 172	Helical - Short - 1/4 λ	4"
SPWB21425	380 - 470	Helical - Standard - 1/4 λ	6.5"
SPWH21450	425 - 475	Whip - Standard - 1/4 λ	6"
SPHS21450	432 - 468	Helical - Short - 1/4 λ	3"
SPHS21470	452 - 488	Helical - Short - 1/4 λ	3"
SPHS21490	475 - 512	Helical - Short - 1/4 λ	3"
SPWH21832	782 - 882	Whip - Standard - 1/4 λ	3"
SPHL21FT	Field Tunable 136 - 221	Helical - Standard - 1/4 λ	8"
SPWH21FT	Field Tunable 400 - 512	Whip - Standard - 1/4 λ	6"

PORTABLE RADIO ANTENNAS

SPOTS!

SMA FEMALE STANDARD - FLUSH BASE - T2 (SFJ TYPE)

CODE 22

PART NUMBER	FREQUENCY BAND (MHZ)	ANTENNA TYPE	APPROX LENGTH
SPWB22150	136 - 174	Helical - Standard - 1/4 λ	6.75"
SPHL22156	150 - 162	Helical - Standard - 1/4 λ	8"
SPHL22167	160 - 174	Helical - Standard - 1/4 λ	8"
SPWB22425	380 - 470	Helical - Standard - 1/4 λ	6.5"
SPWH22420	395 - 445	Whip - Standard - 1/4 λ	6"
SPWH22450	425 - 475	Whip - Standard - 1/4 λ	6"
SPHS22450	432 - 468	Helical - Short - 1/4 λ	3"
SPWH22470	450 - 490	Whip - Standard - 1/4 λ	6"
SPHS22470	452 - 468	Helical - Short - 1/4 λ	3"
SPHS22490	475 - 512	Helical - Short - 1/4 λ	3"
SPHL22FT	Field Tunable 136 - 221	Helical - Standard - 1/4 λ	8"
SPWH22FT	Field Tunable 400 -512	Whip - Standard - 1/4 λ	6"

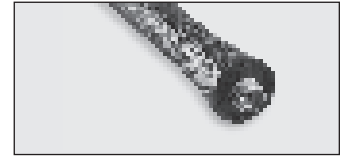

SMA F T2

SMA Female recessed insulator & no skirt (SJF type)
SPOTS! Connector Code 22

SMA FEMALE STANDARD - HALF SKIRT BASE - T3 (SFU TYPE)

CODE 23

PART NUMBER	FREQUENCY BAND (MHZ)	ANTENNA TYPE	APPROX LENGTH
SPWB23150	136 - 174	Helical - Standard - 1/4 λ	6.75"
SPHL23156	150 - 162	Helical - Standard - 1/4 λ	8"
SPHL23167	160 - 174	Helical - Standard - 1/4 λ	8"
SPWB23425	380 - 470	Helical - Standard - 1/4 λ	6.5"
SPWH23450	425 - 475	Whip - Standard - 1/4 λ	6"
SPHS23450	432 - 468	Helical - Short - 1/4 λ	3"
SPWH23470	450 - 490	Whip - Standard - 1/4 λ	6"
SPHS23470	452 - 488	Helical - Short - 1/4 λ	3"
SPWH23490	470 - 512	Whip - Standard - 1/4 λ	6"
SPHS23490	475 - 512	Helical - Short - 1/4 λ	3"
SPHL23FT	Field Tunable 136 - 221	Helical - Standard - 1/4 λ	8"
SPWH23FT	Field Tunable 400 -512	Whip - Standard - 1/4 λ	6"

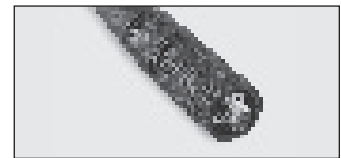

SMA F T3

SMA Female recessed insulator & partial skirt (SFU type)
SPOTS! Connector Code 23

SMA MALE - FLUSH BASE - T2 (SM TYPE)

CODE 24

PART NUMBER	FREQUENCY BAND (MHZ)	ANTENNA TYPE	APPROX LENGTH
SPHL24FT	Field Tunable 136 - 221	Helical - Standard - 1/4 λ	8"
SPWH24FT	Field Tunable 400 -512	Whip - Standard - 1/4 λ	6"

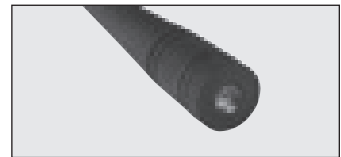

SMA MALE T2

SMA Male flush base (SM Type)
SPOTS! Connector Code 24

MOBILE ANTENNA PLACEMENT

At Larsen we want our customers to be confident they can find the right antenna for the right application. For this reason, we have provided some guidelines for mobile antenna selection.

When selecting a mobile antenna, there are a number of factors which significantly affect the ultimate performance of the antenna. Gain requirements, electrical type, ground plane availability, mounting style and placement, coaxial type and loss ratings, physical size, appearance and surrounding environment are issues to be addressed to ensure the maximum performance from a mobile antenna installation.

For over 40 years, Larsen engineers have been designing high-performance mobile antennas in a variety of electrical types and configurations to meet the most demanding performance criteria and operating conditions. The electrical type or design of the mobile antenna is commonly referred to in terms of its wavelength: 1/4 wave, 1/2 wave, 5/8 wave, etc. Each electrical type has a specific radiating pattern to be considered when selecting a mobile antenna. For example, the signal radiating from a 1/4 wave antenna is directed more vertically, thus making it ideal in urban environments where buildings might obstruct the signal. A 5 dB collinear mobile antenna is designed to direct the signal more towards the horizon. This type of antenna is ideal for geographically flat regions where signal coverage is sparse.

Ground plane availability is another critical factor in mobile antenna performance which must be considered when determining the location and type of the antenna. Ground plane requirements vary given the type of mobile antenna and the frequency of operation. A typical 5/8 wave antenna at 150 MHz requires a ground plane at least 42" in diameter. At 450 MHz a 15" diameter ground plane is required, At 800 MHz a minimum of 8" is considered sufficient.

In terms of mounting mobile antennas on a vehicle, there are five general locations: roof, front fender, rear fender, trunk and rear window glass (although other glass mount locations may be used). Of these, the center of an automobile roof is considered the best for mobile antenna placement, followed by the center of the trunk lid, the fenders, then on-glass mounting. This ranking is determined by the amount of ground plane provided by the positioning and clearance from obstruction (i.e., the roof line). The center of the roof is considered the ideal mounting location, provided the roof is metal. The diagram below illustrates the effective loss (at 800MHz) due to insufficient symmetrical ground plane.

Larsen provides a complete selection of permanent and temporary mounting alternatives, using only the highest quality materials to ensure superior electrical performance and mechanical durability. They include magnetic mounts (MM, MS), trunk gutter brackets (TMB), mirror mount brackets (MB) and, of course, traditional permanent hole mounts for all antenna series.

MOBILE ANTENNA PLACEMENT

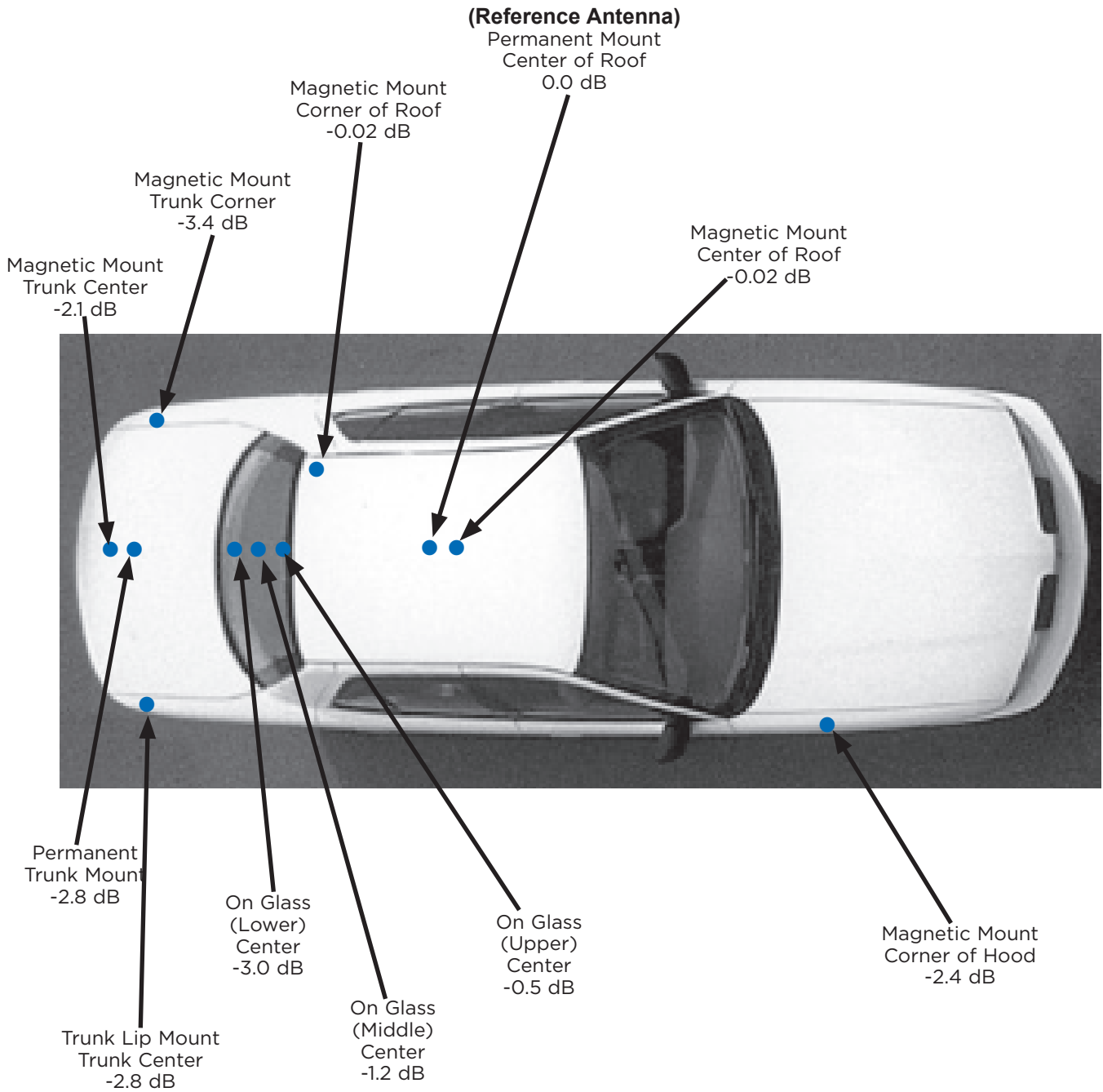

27-136 MHz MOBILE ANTENNAS

27-136 MHz

Model	Type	Frequency (MHz)	Gain (dBd/dBi)	Max Height (In)	Power Rating (Watts)	Whip Color	Cable Assembly/Mount
NMO27B	Loaded 1/4 λ	27-30	0/2	52.5	150	Black	Order Separately
NMO27C	Loaded 1/4 λ	27-30	0/2	52.5	150	Stainless	Order Separately
NMO30B	Loaded 1/4 λ	30-34	0/2	57.5	150	Black	Order Separately
NMO30C	Loaded 1/4 λ	30-34	0/2	57.5	150	Stainless	Order Separately
NMO34B	Loaded 1/4 λ	34-40	0/2	57.5	150	Black	Order Separately
NMO34C	Loaded 1/4 λ	34-40	0/2	57.5	150	Stainless	Order Separately
NMO40B	Loaded 1/4 λ	40-50	0/2	57.5	150	Black	Order Separately
NMO40C	Loaded 1/4 λ	40-50	0/2	57.5	150	Stainless	Order Separately
NMO50B	Loaded 1/4 λ	47-54	0/2	52.5	150	Black	Order Separately
NMO50C	Loaded 1/4 λ	47-54	0/2	52.5	150	Stainless	Order Separately
NMOQ52C	1.4 λ	52-88	0/2	55	150	Stainless	Order Separately
NMOQ88C	Loaded 1/4 λ	88-136	0/2	35	150	Stainless	Order Separately
NMOWB40C	Loaded 1/4 λ	40-50	0/2	55	150	Stainless	Order Separately
Q52	Field tunable 1/4 λ	52-88	0/2	55	200	Stainless	Order Separately
Q88	Field tunable 1/4 λ	88-136	0/2	35	200	Stainless	Order Separately



NOTE: The most commonly used cable assembly/mount is the NMOKHFCX – NMO High Frequency Mount with 17' of CX (RG-58A/U) – for the frequencies listed above.

NOTE: Larsen springs (SPRING or SPRINGB) can be added to most mobile antennas.



136-174 MHz (VHF) ANTENNAS

NMO MOUNTS

Model	Type	Frequency (MHz)	Gain (dBd/dBi)	Max Height (In)	Power Rating (Watts)	Whip Color	Cable Assembly/Mount
NMOWB150B	Wideband 1/2 λ	135-174	0/2	51.75	100	Black	Order Separately
NMOWB150C	Wideband 1/2 λ	135-174	0/2	51.75	100	Stainless	Order Separately
NMO150B	5/8 λ	144-174	3/5.2	51.5	200	Black	Order Separately
NMO150C	5/8 λ	144-174	3/5.2	51.5	200	Stainless	Order Separately
NMO150BHW	1/2 λ	144-174	0/2	51.5	200	Black	Order Separately
NMOQW144	1/4 λ	144-152	0/2	21	200	Stainless	Order Separately
NMOQW152	1/4 λ	152-162	0/2	21	200	Stainless	Order Separately
NMOWBQB	Wideband 1/4 λ	150-170	0/2	20	200	Black	Order Separately
NMOWBQC	Wideband 1/4 λ	150-170	0/2	20	200	Stainless	Order Separately
NMOU150D	Loaded 1/4 λ	150-165	0/2	18	200	Black	Order Separately
NMOU155D	Loaded 1/4 λ	155-170	0/2	18	200	Black	Order Separately

GLASS MOUNT

Model	Type	Frequency (MHz)	Gain (dBd/dBi)	Max Height (In)	Power Rating (Watts)	Whip Color	Cable	Connector
KG144UDPL	1/2 λ	144-160	0/2	48	100	Black	14' RG-58/U Dual Shield	PL-259
KG160UD	1/2 λ	160-174	0/2	47	100	Black	14' RG-58/U Dual Shield	No Connector
KG160UDPL	1/2 λ	160-174	0/2	47	100	Black	14' RG-58/U Dual Shield	PL-259

LM MOUNT

Model	Type	Frequency (MHz)	Gain (dBd/dBi)	Max Height (In)	Power Rating (Watts)	Whip Color	Cable Assembly/Mount
LM150B	5/8 λ	144-174	3/5.14	51.75	200	Black	Order Separately
LM150C	5/8 λ	144-174	3/5.14	51.75	200	Stainless	Order Separately
LMWBQ	Wideband 1/4 λ	150-170	0/2.14	18.5	200	Stainless	Order Separately
LMWBQB	Wideband 1/4 λ	150-170	0/2.14	18.5	200	Black	Order Separately



NOTE: The most commonly used cable assembly/mount is the NMOHFCX — NMO High Frequency Mount with 17' of CX (RG-58A/U) — for the frequencies listed above.

136-174 MHz (VHF) ANTENNAS

MHW/PO Series Base Coil



OM Series



PHW Series Base Coil



MSTFME

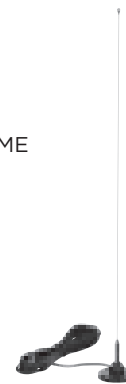

MISCELLANEOUS MOUNTS

Model	Mount Style	Type	Frequency (MHz)	Max Gain (dBd/dBi)	Power Height (In)	Rating (Watts)	Whip Color	Cable	Connector
MHW150C	PO/SO-239	1/2 λ	144-174	0/2	51.5	200	Stainless		Order Separately
OM150CK	Self-mounting	1/2 λ	144-174	0/2	51.75	200	Stainless	17' RG-58A/U	PL-259
PHW150C	SO-239	1/2 λ	144-174	0/2	56.5	200	Stainless		Order Separately
PO150B	PO/SO-239	5/8 λ	144-174	3/5.2	51.5	200	Black		Order Separately
PO150C	PO/SO-239	5/8 λ	144-174	3/5.2	51.5	200	Stainless		Order Separately
MSTFME	Magnetic	1/4 λ	144-965	0/2	21	50	Black	12' RG-174	FME Crimp

A Successful Installation

A successful installation means that all product instructions are read, the right tools are available, and best practices applied. Below are a few tips to ensure your antenna performs as specified.

NMO Mounts: One way of ensuring proper grounding of your antenna system is to clear the paint on the underside of the mounting surface, such as the roof or trunk, with a medium grit sandpaper or other by other means. The NMO mounting hardware is designed to “cut” into the paint, however, paint thickness and total applied mounting torque may make conditions where grounding is insufficient. The VSWR of the mounted antenna is the primary indicator that the ground is poor.

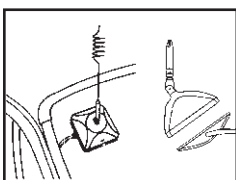
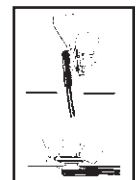

Glass Mounts: Glass mounts have very specific instructions for preparing the glass for an on-glass antenna and should be strictly followed. The most important instructions are to clean the glass avoiding ammonia-based cleaners, glass temperature must be close to room temperature (70 degrees), and after install, the whip should remain off and the mount dry for 24-72 hours. By preparing and installing correctly, you can rest assured knowing that your antenna is not going anywhere.

Tuning: Many users trust that the cutting charts provided with an antenna are absolute. It should be reinforced that cutting charts are guidelines. Ground plane size (a car versus a van), antenna mounting locations (the roof versus the trunk), and even mounting types (permanent roof mount versus magnetic mount versus trunk lip mounts) all have an impact in the tuning of an antenna. Using the cut chart with an economic SWR meter will help ensure the antenna is tuned correctly.

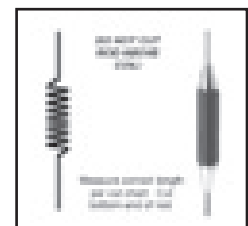

NOTE: The most commonly used cable assembly/mount is the NMOHF CX — NMO High Frequency Mount with 17' of CX (RG-58A/U) — for the frequencies listed above.

220-225 MHz ANTENNAS

Appearance. Performance. Dependability. Long-term service. Those are key words describing Larsen 220 MHz mobile antennas. Larsen offers 220 MHz antennas in 1/2 wave and 5/8 wave designs for coverage in the 220 MHz to 225 MHz band.

High-performance Larsen 220 MHz antennas are available in the NMO Premium Motorola-style 3/4" hole mount version.

Count on Larsen 220 MHz antennas to deliver these superior performance advantages:

- Handles a full 200 Watts of power
- VSWR at 1.5:1 or less
- Heavy-duty base coils are air wound for lowest RF loss
- Available with black or stainless whips
- Optional shock spring internally shorted with highly flexible insulated wire to eliminate distortion
- Durable MakroBlend® shells are UV and chemical resistant

NMO MOUNTS

Model	Type	Frequency (MHz)	Gain (dBd/dBi)	Max Height (In)	Power Rating (Watts)	Whip Color	Cable Assembly/Mount
NMO220B	5/8 λ	220-225	3/5.2	30	200	Black	Order Separately
NMO220C	5/8 λ	220-225	3/5.2	30	200	Stainless	Order Separately
NMO220CHW	1/2 λ	220-225	0/2	30	200	Stainless	Order Separately

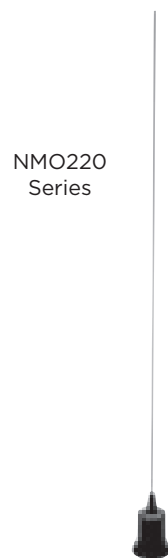

NOTE: The most commonly used cable assembly/mount is the NMOKHFCX — NMO High Frequency Mount with 17' of CX (RG-58A/U) — for the frequencies listed above.

406-440 MHz (UHF) ANTENNAS

NMO MOUNTS

Model	Type	Frequency (MHz)	Gain (dBd/dBi)	Max Height (In)	Power Rating (Watts)	Whip Color	Cable Assembly/Mount
NMO406C	5/8 Over 1/2 λ	406-420	3.4/5.6	33	200	Stainless	Order Separately
NMO406CHW	1/2 λ Collinear	406-420	5.5/7.6	35.5	100	Stainless	Order Separately
NMO4063CS	5/8 λ	406-430	3/5.2	19	200	Stainless	Order Separately
NMOWB406C	Wide Band	406-430	3.5/5.5	35.5	200	Stainless	Order Separately
NMOQW406	1/4 λ	406-430	0/2	7	200	Stainless	Order Separately
NMO420C	5/8 Over 1/2 λ	420-440	3.4/5.6	33	200	Stainless	Order Separately
NMO420CHW	1/2 λ Collinear	420-440	5.5/7.6	35.5	100	Stainless	Order Separately
NMO4303CS	5/8 λ	430-450	3/5.2	19	200	Stainless	Order Separately
NMOWB430C	Wide Band	430-455	3.5/5.5	35.5	200	Stainless	Order Separately
NMO440C	5/8 Over 1/2	440-460	3.4/5.6	33	200	Stainless	Order Separately
NMO440CHW	1/2 λ Collinear	440-460	5.5/7.6	35.5	100	Stainless	Order Separately

NMO400 Series



NMO CS Series



NMOWB Series



NMO HW Series



NMOQW



NOTE: The most commonly used cable assembly/mount is the NMOKHFCX – NMO High Frequency Mount with 17' of CX (RG-58A/U) – for the frequencies listed above.

406-440 MHz (UHF) ANTENNAS

GLASS MOUNT

Model	Type	Frequency (MHz)	Gain (dBd/dBi)	Max Height (In)	Power Rating (Watts)	Whip Color	Cable	Connector
KG406UDPL	1/2 λ	406-240	0/2	15	100	Black	14' RG-58/U Dual Shield	PL-259T
KG420UDPL	1/2 λ	420-440	0/2	15	100	Black	14' RG-58/U Dual Shield	PL-259T



LM MOUNT

Model	Type	Frequency (MHz)	Gain (dBd/dBi)	Max Height (In)	Power Rating (Watts)	Whip Color	Cable Assembly/Mount
LM406C	5/8 over 1/2 λ	406-420	3.5/5.6	33	200	Stainless	Order Separately
LM420C	5/8 over 1/2 λ	420-440	3.5/5.6	33	200	Stainless	Order Separately
LM440C	5/8 over 1/2 λ	440-460	3.5/5.6	33	200	Stainless	Order Separately

NOTE: The most commonly used cable assembly/mount is the NMOXHFCX — NMO High Frequency Mount with 17' of CX (RG-58A/U) — for the frequencies listed above.

1 800 ANTENNA (268-3662)

406-440 MHz (UHF) ANTENNAS



LOW PROFILE

Model	Mount Style	Frequency (MHz)	Gain (dBd/dBi)	Height (In)	Diameter (In)	Power Rating (Watts)	Color	Cable Assembly/Mount
LP406NMO	NMO	406-420	0/2	1.5	4.5	100	Black	Order separately
LP406NMOW	NMO	406-420	0/2	1.5	4.5	100	White	Order separately
LP420NMO	NMO	416-430	0/2	1.5	4.5	100	Black	Order separately
LP420NMOW	NMO	416-430	0/2	1.5	4.5	100	White	Order separately



OM Series

MSTFME



MISCELLANEOUS MOUNTS

Model	Mount Style	Type	Max Frequency (MHz)	Power Gain (dBd/dBi)	Height (In)	Rating (Watts)	Whip Color	Cable	Connector
MSTFME	Magnetic	1/4 λ	144-965	0/2	21	50	Black	12' RG-174	FME Crimp
OM406CK	Self-mounting	1/2 λ Collinear	406-420	3/5.5	35.5	100	Stainless	17' RG-58A/U	PL-259
OM420CK	Self-mounting	1/2 λ Collinear	420-440	3/5.5	35.5	100	Stainless	17' RG-58A/U	PL-259

NOTE: The most commonly used cable assembly/mount is the NMOKHFCX – NMO High Frequency Mount with 17' of CX (RG-58A/U) – for the frequencies listed above.

www.pulseelectronics.com/products/antennas

VHF/UHF MULTIBAND ANTENNAS

NMO MOUNTS

Model	Type	Frequency (MHz)	Gain (dBd/dBi)	Max Height (In)	Power Rating (Watts)	Whip Color	Cable Assembly/Mount
NMO2/70B	Center Loaded 1/2 λ / Collinear	144-148/ 440-450	1.6/3.8 3/5.2	34.75	100	Black	Order Separately
NMO2/70SH	Center Loaded 1/4 λ / Center Loaded 1/2 λ	144-148/ 440-450	0/2 4/2	19	200	Stainless	Order Separately
NMO150/450C	Center Loaded 1/2 λ / Collinear	150-154/ 450-460	1.6/3.8 3/5.2	37.75	100	Stainless	Order Separately
NMO150/450/800	Tri Band	150-165/ 450-470 806-960	0/2 0/2 0/2	16.5	100	Black	Order Separately

GLASS MOUNT

Model	Type	Frequency (MHz)	Gain (dBd/dBi)	Max Height (In)	Power Rating (Watts)	Whip Color	Cable	Connector
KG2/70CXPL	1/2 λ / Collinear	144-148/ 442-448	0/2 2/4.2	32.75	100	Black	14' RG-58A/U	PL-259
KG2/70CXFME	1/2 λ / Collinear	144-148/ 442-448	0/2 2/4.2	32.75	100	Black	14' RG-58A/U	FME



NOTE: The most commonly used cable assembly/mount is the NMOKHFCX — NMO High Frequency Mount with 17' of CX (RG-58A/U) — for the frequencies listed above.

1 800 ANTENNA (268-3662)

TUNABLE 1/4 WAVE (136-152 MHz) ANTENNAS

Tunable 1/4 Waves

Model	Mount Style	Frequency (MHz)	Gain (dBd/dBi)	Max Height (In)	Power Rating (Watts)	Whip Color	Cable	Connector
NMOQB	NMO	136-512	0/2	23	200	Black	Order Separately	Order Separately
NMOQC	NMO	136-512	0/2	23	200	Stainless	Order Separately	Order Separately
PQ	PO/SO-239	136-512	0/2	22	200	Stainless	Order Separately	Order Separately
QB	LM	136-512	0/2	22	200	Black	Order Separately	Order Separately
Q	LM	136-512	0/2	22	200	Stainless	Order Separately	Order Separately
NMOQSPECB	NMO	136-960	0/2	22	200	Black	Order Separately	Order Separately
NMOQSPEC	NMO	136-960	0/2	22	200	Stainless	Order Separately	Order Separately
MSTFME	Magnetic	144-965	0/2	21	50	Black	12' RG-174	FME Crimp

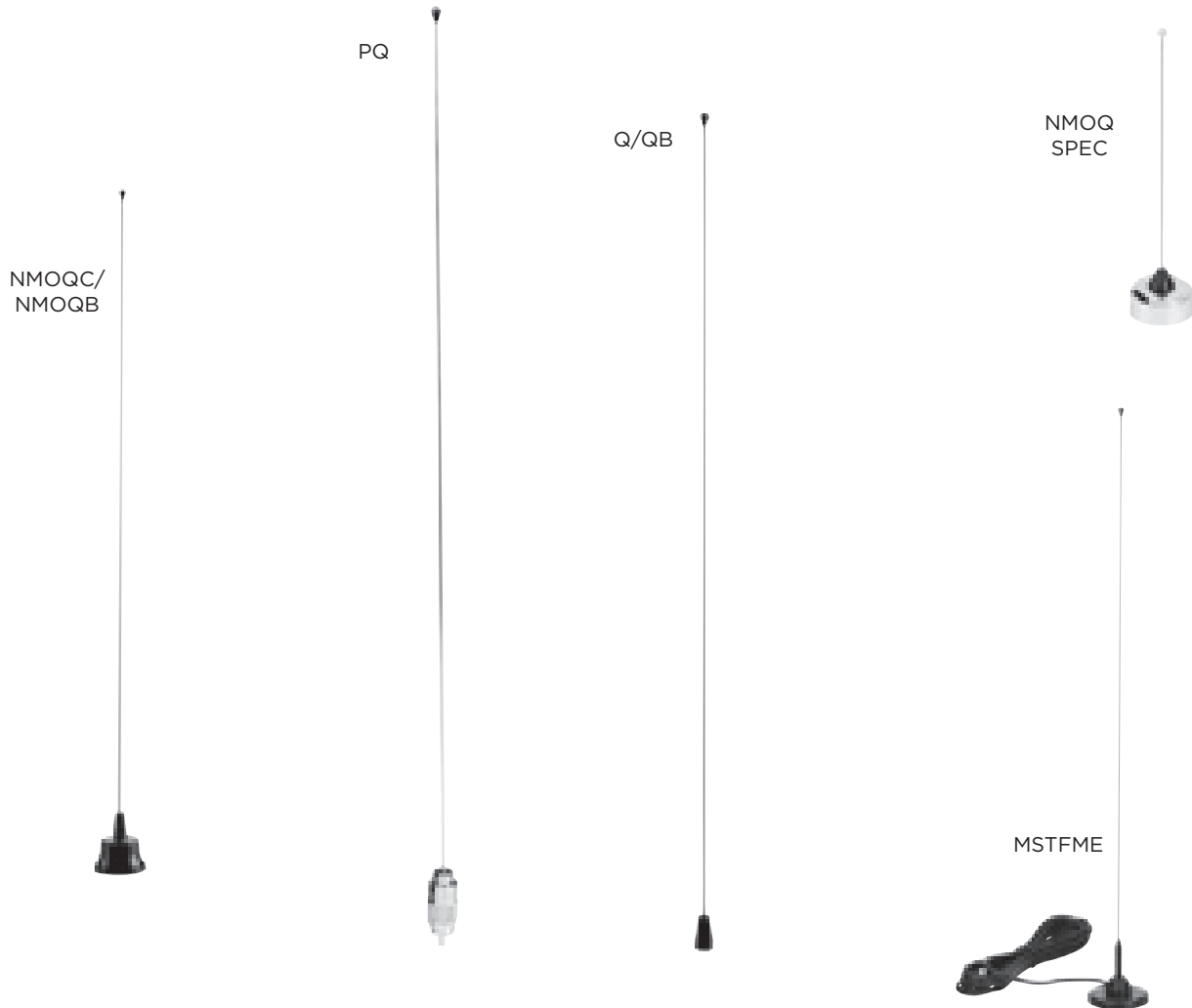

NOTE: The most commonly used cable assembly/mount is the NMOKHFCX – NMO High Frequency Mount with 17' of CX (RG-58A/U) – for the frequencies listed above.

www.pulseelectronics.com/products/antennas

COAXIAL CABLE

Premium quality coax for applications from low-band to 6 GHz

RG-58 A/U, Stranded Larsen Part Number: CXCOAX

This cable serves well as a high-quality, low-cost coax for most applications below 512 MHz. Typical loss figures (per 100' of cable) are 6.8 dBd at 150 MHz and 12.9 dBd at 450 MHz. Due to its relatively high loss at higher UHF frequencies (18.3 dBd per 100' at 825 MHz), it is not usually recommended for use above 512 MHz. The stranded center conductor offers very good flexibility and long life under most conditions. Jacket material: Black PVC. Insulator material: Solid Polyethylene.

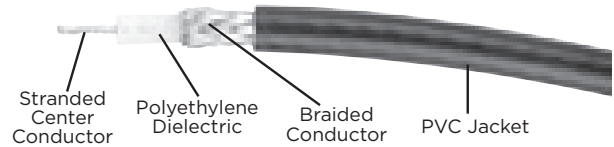

RG-58 A/U Dual Shield, Stranded Larsen Part Number: DSCOAX

RG-58 A/U coax employs two shields consisting of a full aluminum/mylar wrap covered by a braid. This combination of shields, plus low-loss dielectric material and stranded center conductor makes an excellent choice for mobile applications. It has the right combination of low-loss (12.6 dBd per 100' at 825 MHz), excellent flexibility and uses standard connectors. Jacket material: Black PVC. Insulator material: Foam Polyethylene. Larsen products using this coax are identified by "DS" in the part number.

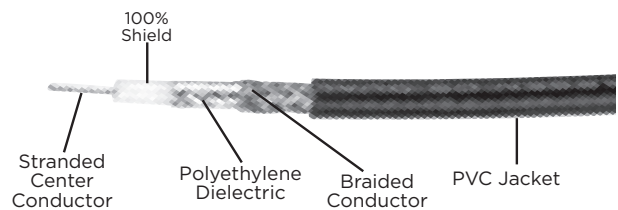

RG-58/U Dual Shield, Solid Larsen Part Number: UDCOAX

This is Larsen's premium coax for 800 and 900 MHz applications. The solid center conductor (20 AWG) is easy to use with all connectors. Digital applications in particular benefit from the 100% Duofoil aluminum shield. The shield is not glued to the dielectric making it easier to peel back for connector installation. The braid is 95% coverage. Jacket material: Black PVC. Insulator material: Polyethylene. This cable is standard for most mounting kits used for 800 MHz and can be special ordered for use with other frequencies. Larsen products using this coax are identified by "UD" in the part number.

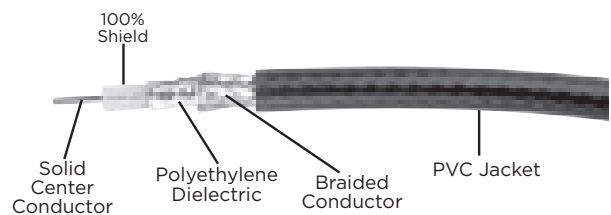

RG-213, Stranded Larsen Part Number: RG213

This RG-8-size coax uses a stranded center conductor, polyethylene dielectric and non-contaminating black PVC jacket making it ideal for outdoor applications where it will be exposed to ultraviolet light. Loss per 100' is from 2.7 dBd at 150 MHz to 8 dBd at 900 MHz.

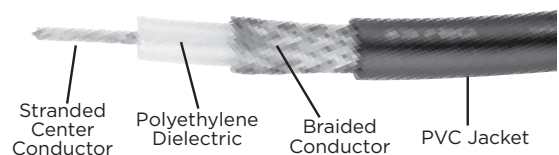

CABLE ASSEMBLIES

When it comes to installing antennas, installers face new challenges every day. Automobile manufacturers create sleek new designs with curved surfaces utilizing less and less metal. In addition, people are less willing to drill a hole in expensive new cars. This creates problems when trying to install an antenna to achieve maximum performance.

Larsen, recognizing this issue, has developed a full line of permanent and temporary mounts to solve virtually every installation need. Each Larsen mount is manufactured of the highest quality materials, including premium coax.

Note: Connectors are shipped loose/uninstalled with all mounting kits except MMR magnetic mounts. An FME universal adapter is installed on all kits.

NMOHF MOUNTS

All Larsen NMOHF (high frequency) mounts convert from low frequency applications to high frequency applications and back by pulling or replacing the center pin and insulator.

NMOHF mounts require a 3/4" hole for mounting and include 17' of coax unless otherwise indicated.



NMOHF Mount
Low Frequency Configuration



NMOHF Mount
High Frequency Configuration

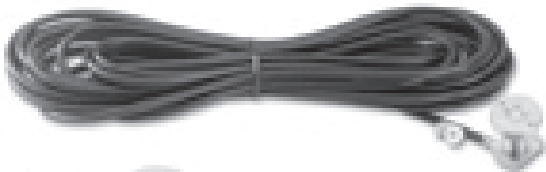

NMOHF Thick Mount
Low Frequency Configuration



NMOHF Thick Mount
High Frequency Configuration

NMO 3/4" HIGH FREQUENCY MOUNTS

Model	Coax	Connector
NMOKHFCX	CX (RG-58A/U)	No Connector
NMOKHFCXFME	CX (RG-58A/U)	FME Crimp
NMOKHFCXMPL	CX (RG-58A/U)	MINI UHF
NMOKHFCXPL	CX (RG-58A/U)	PL-259
NMOKHFUD	UD (RG-58U Dual Shield)	No Connector
NMOKHFUDFME	UD (RG-58U Dual Shield)	FME
NMOKHFUDMPL	UD (RG-58U Dual Shield)	MPL
NMOKHFUDSMA	UD (RG-58U Dual Shield)	SMA
NMOKHFUDTNC	UD (RG-58U Dual Shield)	TNC
NMOKHFUDPL	UD (RG-58U Dual Shield)	PL-259

Larsen NMOHF mounts are also available with DS (RG-58A/U Dual Shield) and LMR200 coax. For more information, please contact your local dealer.

NMO 3/4" HIGH FREQUENCY THICK MOUNTS

Model	Coax	Connector
NMOKHFCXTHK	CX (RG-58A/U)	No Connector
NMOKHFUDTHK	UD (RG-58U Dual Shield)	No Connector

NMOHFTHK (thick) mounts accommodates roof surfaces up to 1/2" thick.

Larsen NMOHF mounts are also available with DS (RG-58A/U Dual Shield) and LMR200 coax. For more information, please contact your local dealer.

NMOHF MOUNTS

All Larsen NMOHF (high frequency) mounts convert from low frequency applications to high frequency applications and back by pulling or replacing the center pin and insulator.

NMOHF mounts require a 3/4" hole for mounting and include 17' of coax unless otherwise indicated.

NMO HIGH FREQUENCY MAGNETIC MOUNTS

Model	Coax	Connector
NMOMMRNOCONN	CX (RG-58A/U)	No Connector
NMOMMRFME	CX (RG-58A/U)	FME Crimp
NMOMMRMPL	CX (RG-58A/U)	MPL Crimp
NMOMMRN	CX (RG-58A/U)	N Crimp
NMOMMR	CX (RG-58A/U)	58FCP
NMOMMRPL	CX (RG-58A/U)	PL-259
NMOMMRMPL	CX (RG-58A/U)	MPL Crimp
NMOMMRTNC	CX (RG-58A/U)	TNC Crimp
NMOMMRBNC	CX (RG-58A/U)	BNC Crimp

NMOHF magnetic mounts are 3.5" in diameter, have a pull strength of 80 pounds and include 12' of coax.

Larsen NMOHF magnetic mounts are also available with DS (RG-58A/U Dual Shield) and LMR200 coax. For more information, please contact your local dealer.



NMOHF MIRROR MOUNTS

Model	Coax	Connector
NMOKHFMBXC	CX (RG-58A/U)	No Connector
NMOKFHMBUD	UD (RG-58U Dual Shield)	No Connector



CABLE ASSEMBLIES

NMO STANDARD MOUNTS

Standard NMO mounts require a 3/4" hole for mounting and include 17' of coax unless otherwise indicated.

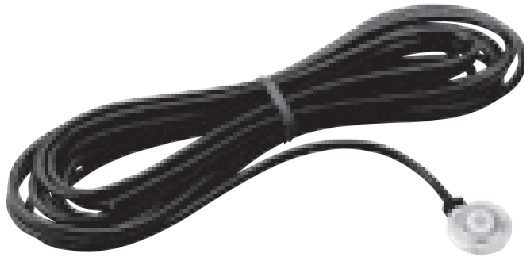

NMO 3/4" STANDARD MOUNTS

Model	Coax	Connector
NMOKNOCOENN	CX (RG-58A/U)	No Connector
NMOKFME	CX (RG-58A/U)	FME Crimp
NMOKMPL	CX (RG-58A/U)	MPL Crimp
NMOKN	CX (RG-58A/U)	N Crimp
NMOK	CX (RG-58A/U)	PL-259
NMOKTNC	CX (RG-58A/U)	TNC Crimp
NMOKBNC	CX (RG-58A/U)	BNC Crimp
NMOKUD	UD (RG-58U Dual Shield)	No Connector
NMOKUDFME	UD (RG-58U Dual Shield)	FME Crimp
NMOKUDMPL	UD (RG-58U Dual Shield)	MPL Crimp
NMOKUDN	UD (RG-58U Dual Shield)	N Crimp
NMOKUDPL	UD (RG-58U Dual Shield)	PL-259
NMOKUDSMA	UD (RG-58U Dual Shield)	SMA Male
NMOKUDTNC	UD (RG-58U Dual Shield)	TNC Crimp

Larsen standard NMO mounts are also available with DS (RG-58A/U Dual Shield) coax. For more information, please contact your local dealer.

NMO STANDARD MAGNETIC MOUNTS



Model	Coax	Connector
NMOMMNOCONN	CX (RG-58A/U)	No Connector
NMOMMMPL	CX (RG-58A/U)	MPL Crimp
NMOMMM	CX (RG-58A/U)	58FCP
NMOMMMBNC	CX (RG-58A/U)	BNC Crimp
NMOMMPL	CX (RG-58A/U)	PL-259T
NMOMMMFME	CX (RG-58A/U)	FME Crimp
NMOMMTNC	CX (RG-58A/U)	TNC Crimp
NMOMMUDN	UD (RG-58U Dual Shield)	N

Standard NMO magnetic mounts are 3.5" x 3", have a pull strength of 90 pounds and include 12' of coax.

Larsen standard NMO magnetic mounts are also available with DS (RG-58A/U Dual Shield). For more information, please contact your local dealer.

NMO STANDARD MOUNTS

Standard NMO mounts require a 3/4" hole for mounting and include 17' of coax unless otherwise indicated.

NMO 3/8" THICK MOUNTS

Model	Coax	Connector
NMOKCX38THK	CX (RG-58A/U)	No Connector
NMOKUD38THK	UD (RG-58U Dual Shield)	No Connector

NMO 3/8" mounts require a 3/8" hole for mounting and include 17' of coax. The NMO38THK mount is designed for mounting surfaces with a thickness of 0.15" to 0.22".

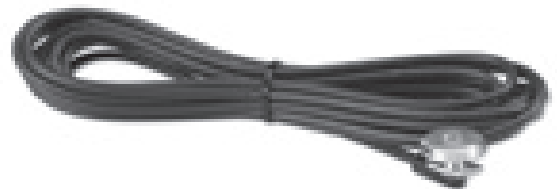

NMO TRUNK LIP MOUNTS

Model	Coax	Connector
NMOTLP	CX (RG-58A/U)	PL-259
NMOTLPFME	CX (RG-58A/U)	FME Crimp
NMOTLPMPL	CX (RG-58A/U)	MPL Crimp

The NMOTLP mount is a Motorola style trunk lid mount, 2.5" x 2" with 17' of coax.



NMO TRUNK GUTTER MOUNTS

Model	Coax	Color	Connector
NMOTMB	CX (RG-58A/U)	Stainless	PL-259

The NMOTMB Motorola style trunk gutter bracket is 1.75" x 1.75" with 17' of coax.



CABLE ASSEMBLIES

LM MOUNTS

All Larsen LM cable assemblies include 17' of coax unless otherwise indicated.



LM 3/4" MOUNTS

Model	Coax	Connector
LMKNOCNN	CX (RG-58A/U)	No Connector
LMKFME	CX (RG-58A/U)	FME Crimp
LMKMPL	CX (RG-58A/U)	MPL Crimp
LMKN	CX (RG-58A/U)	N Crimp
LMK	CX (RG-58A/U)	PL-259
LMKTNC	CX (RG-58A/U)	TNC Crimp
LMKUD	UD (RG-58U Dual Shield)	No Conn
LMUDFME	UD (RG-58U Dual Shield)	FME Crimp
LMKUDMPL	UD (RG-58U Dual Shield)	MPL Crimp
LMKUDN	UD (RG-58U Dual Shield)	N Crimp
LMKUDTNC	UD (RG-58U Dual Shield)	TNC Crimp

LM mounts are 5/16" x 24 THDS roof mount requiring a 3/4" hole.

Larsen LM mounts are also available with DS (RG-58A/U Dual Shield) coax. For more information, please contact your local dealer.

LM MAGNETIC MOUNTS

Model	Coax	Connector
LMMMFMFME	CX (RG-58A/U)	FME Crimp
LMMMFMPL	CX (RG-58A/U)	MPL Crimp
LMMM	CX (RG-58A/U)	58FCP
LMMMNTNC	CX (RG-58A/U)	TNC Crimp
LMMMNBNC	CX (RG-58A/U)	BNC Crimp
LMMMPL	CX (RG-58A/U)	PL-259

LM magnetic mounts are 5/16" x 24 THDS roof mount, 3.5" x 3" with a pull strength of 50 pounds and include 12' of coax.

Larsen LM magnetic mounts are also available with DS (RG-58A/U Dual Shield) coax. For more information, please contact your local dealer.

LM TRUNK LIP MOUNTS

Model	Coax	Connector
LMTLP	CX (RG-58A/U)	PL-259

The LMTLP mount is 5/16" x 24 THDS trunk lid mount, 2.5" x 2".

Larsen LMTLP mounts are also available with DS (RG-58A/U Dual Shield) coax. For more information, please contact your local dealer.

LM TRUNK GUTTER MOUNTS

Model	Coax	Connector
LMTMB	CX (RG-58A/U)	PL-259

The LMTMB trunk gutter bracket is 1.75" x 1.75" and comes with a LMK cable assembly.

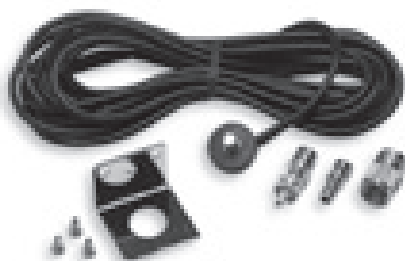

PO MOUNTS

PO 3/4" MOUNTS

Model	Coax	Connector
POKNOCONN	CX (RG-58A/U)	No Connector
POK	CX (RG-58A/U)	PL-259

PO mounts are an SO-239 female type roof mount requiring a 3/4" hole and includes 17' of coax.



PO MAGNETIC MOUNTS

Model	Coax	Connector
POMMM	CX (RG-58A/U)	58FCP

The PO magnetic mount is an SO-293 female type, 3.5" x 3" with a pull strength of 50 pounds and includes 12' of coax.



SMALL BASE STATION ANTENNAS

The following antennas have a VSWR of 1.5:1, power rating of 200 Watts and a UHF Female feed connection.

BSA SERIES

Model	Type	Frequency (MHz)	Gain (dBd/dBi)	VSWR	Length (In)
BSA45C	Base loaded $1/4 \lambda$	45-50	0/2	1.5:1	51.75
BSA118B	$5/8 \lambda$	118-121	3/5.2	1.5:1	51.75
BSA132B	$5/8 \lambda$	131-135	3/5.2	1.5:1	54.5
BSA150B	$5/8 \lambda$	144-174	3/5.2	1.5:1	51.75
BSA150C	$5/8 \lambda$	144-174	3/5.2	1.5:1	51.75
BSA220C	$5/8 \lambda$	220-225	3/5.2	1.5:1	33.75

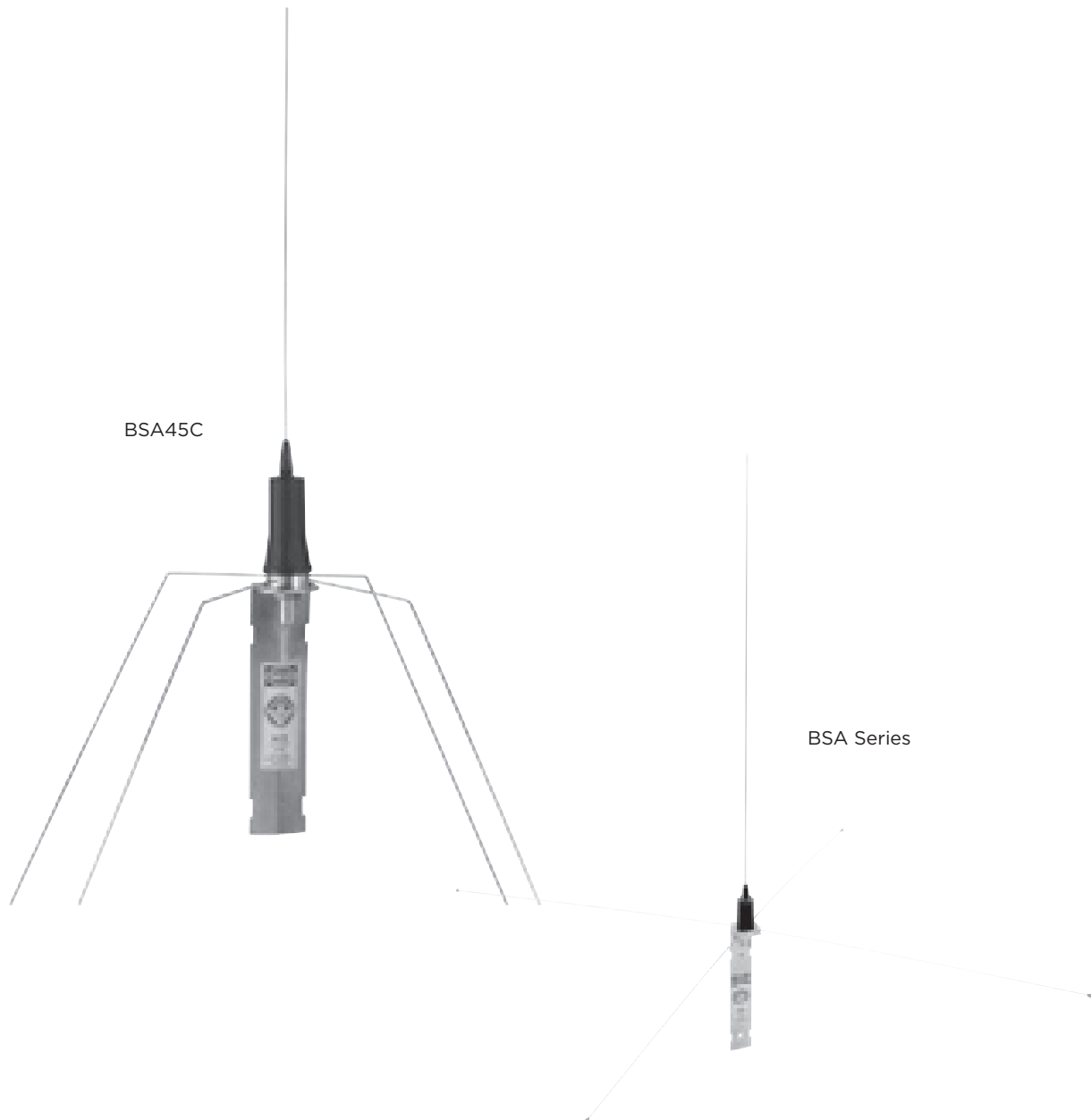

SMALL BASE STATION ANTENNAS

FB SERIES

Model	Type	Frequency (MHz)	Gain (dBd/dBi)	VSWR	Length (In)	Power (Watts)	Feed Connection
FB1136	5/8 over 1/2 λ	136-230	3.5/5.6	1.5:1	96	200	UHF Female
FB2406	5/8 over 1/4 λ	406-420	3.2/5.4	1.5:1	32.25	200	N Female
FB2420	5/8 over 1/4 λ	420-440	3.2/5.4	1.5:1	32.25	200	N Female

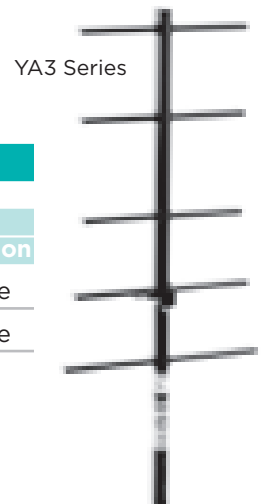
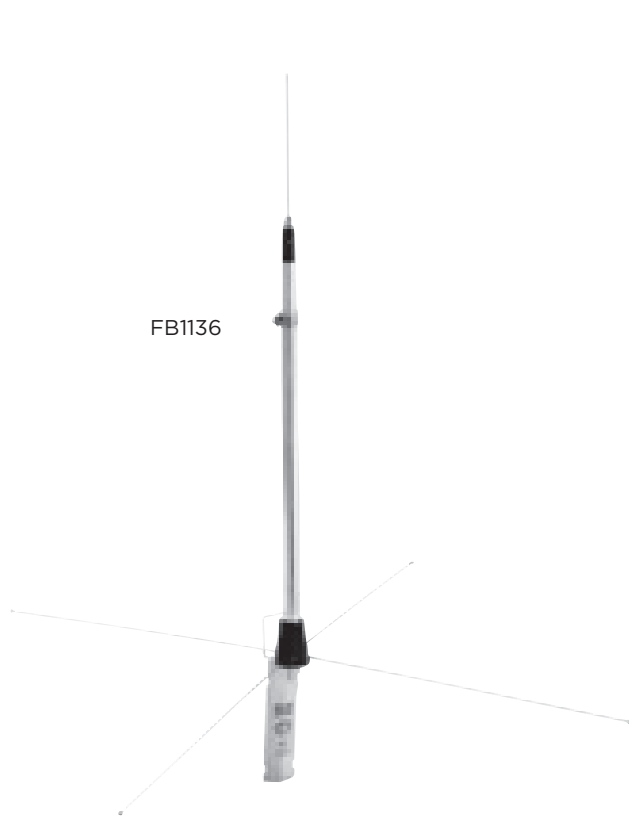

YA SERIES

Model	Type	Frequency (MHz)	Gain (dBd/dBi)	VSWR	Length (In)	Power (Watts)	Feed Connection
YA3406WN	5-element	406-430	9/11	2:1	42.25	300	N Female
YA3450WN	5-element	450-470	9/11	2:1	36.25	300	N Female

REPLACEMENT PARTS/ACCESSORIES



ANTENNA CONES	
PART NUMBER	DESCRIPTION
QCONE.073	Cone with .073" blind hole used for Q antennas. Chrome.
QCONE.073B	Same as above in black.
QCONE.100	Cone with .100" blind hole used for on VHF or UHF gain and Q52 and Q88 antennas. Chrome.
QCONE.100B	Same as above in black.
QCONE.125	Cone with .125" blind hole used on 800 MHz closed coil and all WBQ antennas. Chrome.
QCONE.125B	Same as above in black.



BATTERY BOLT	
PART NUMBER	DESCRIPTION
Replaces side mount battery bolts with a longer terminal for additional power connections with 3/8" ring leads. All brass unit comes complete with crimp terminal and nut.	
BATTBOLT	Battery bolt with terminal.



BSA KIT	
PART NUMBER	DESCRIPTION
BSAKIT	Base station ground plane kit, 200 Watts, UHF Female feed connection.

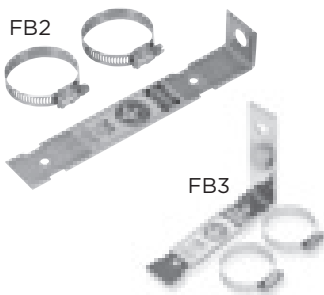

FB SERIES MOUNTING BRACKETS	
PART NUMBER	DESCRIPTION
FB2BRACKET	Mounting bracket and hardware for FB2 series.
FB3BRACKET	Mounting bracket and hardware for FB3 Series.

REPLACEMENT PARTS/ACCESSORIES

GASKETS	
PART NUMBER	DESCRIPTION
RGNMOANT	Rubber gasket internal to NMO coils, 3 per pkg.
RGOMANT	Rubber gasket for OM series coils, 3 per pkg.
RGFB1ANT	Rubber gasket for FB1 series, 1 per pkg.
RGPOMNT	Rubber gasket for PO series coils, 3 per pkg.
RGSBKmnt	Rubber gasket for SBK mounts, 3 per pkg
RGSS	Rubber SuperSeal gasket for MakroBlend coils/bases, 3 per pkg.

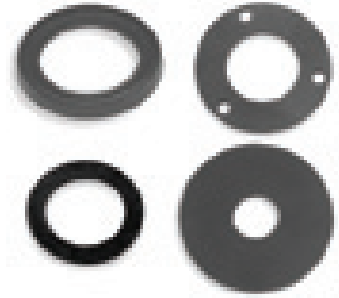

GROMMETS AND HOLE PLUGS	
PART NUMBER	DESCRIPTION
GROMMETS	Plastic grommet locks securely into a 3/4" hole and grips the coax to hold it in the center. 100 per pkg.
HP34	Plastic hole plug for 3/4" hole when antenna is removed but not replaced. 5 per pkg.
HP38	Plastic hole plug for 3/8" hole when antenna is removed but not replaced. 6 per pkg.

Grommets



Hole Plugs

HOLE SAW	
PART NUMBER	DESCRIPTION
HS1	Designed specifically for installing permanent mount mobile antennas. Makes a 3/4" hole and limits hole depth to 1/8". Fits 3/8" or larger electric drill. Includes 2 blades.
HSBLADE	Replacement blades for HS1, 2 per pkg.

Hole Saw

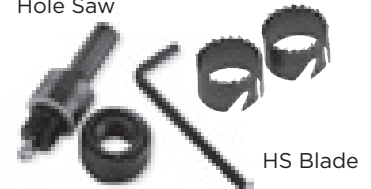

HS Blade

KG REINSTALL KITS	
PART NUMBER	DESCRIPTION
KGREINSTALL	KG glass mount reinstall kit with die cut tape.



KG SWIVEL MOUNTS	
PART NUMBER	DESCRIPTION
KGSWIVEL.073	KG swivel mount assembly, .073 diameter.
KGSWIVEL.100	KG swivel mount assembly, .100 diameter.



REPLACEMENT PARTS/ACCESSORIES



MOUNT BRACKETS	
PART NUMBER	DESCRIPTION
TMB34	Stainless steel trunk gutter bracket, 3/4" diameter hole. Screws included.
TMB38B	Same as above in black.
TMB38	Stainless steel trunk gutter bracket, 3/8" diameter hole. Screws included.
TMB38B	Same as above in black.
TMB58	Stainless steel trunk gutter bracket, 5/8" diameter hole. Screws included.
TMB58B	Same as above in black.
TMB34D	Fender bracket only. Fits Dodge Ram trucks year 2002 and older.
TMBOM	Stainless steel trunk gutter bracket for OM antennas, screws included



NMO MOUNT ADAPTER	
PART NUMBER	DESCRIPTION
A4	BSA/BA/SO-239 to NMO mount adapter



O-RINGS	
PART NUMBER	DESCRIPTION
OLMNT	O-Ring for LM mounting hardware, 3 per pkg
ONMOMNT	O-Ring for NMO mounting hardware, 3 per pkg
ONMOANT	O-Ring for NMO coils and bases, 3 per pkg
OPOMNT	O-Ring for PO mounting hardware, 3 per pkg



RAIN CAPS	
PART NUMBER	DESCRIPTION
LMCAPB	Rain cap for LM mount.
NMOCAPB	Rain cap for NMO mount.

ROD TIPS	
PART NUMBER	DESCRIPTION
BALL1B	Black rod tip for W490, W540 tapered rods. 10 per pkg.
BALL2B	Black rod tip for Q and NMOQ antennas. 10 per pkg.
BALL3B	Black rod tip for .100 diameter non-tapered rods. 10 per pkg.



SET SCREWS	
PART NUMBER	DESCRIPTION
#6-32	Allen head set screws used on NMOQSPEC. Bag of 25.
#8-32	Allen head set screws used on all coils. Bag of 25.
#10-32	Allen head set screws used on all TLP mounts. Bag of 25.

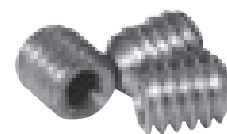

SPANNER WRENCH	
PART NUMBER	DESCRIPTION
SPANNER	Spanner wrench for PO and NMO mounts



SPRING	
PART NUMBER	DESCRIPTION
SPRING	Chrome shock spring for Larsen VHF and UHF antennas.
SPRINGB	Black shock spring for Larsen VHF and UHF antennas.

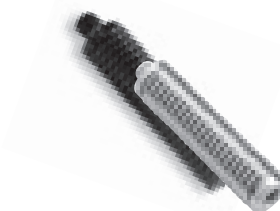

TEST MOUNT ADAPTER	
PART NUMBER	DESCRIPTION
NMOTEST1	Test adaptor for NMO mount allows checking of coax feeding by allowing dummy load to replace the antenna. Also used to extend coax line to temporarily remote an antenna. Features floating contact design, good SWR match into 800 MHz range and nickel-plated brass construction.

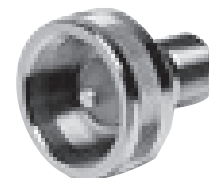

PulseLARSEN *Antennas*

To order Larsen Amateur antennas,
please contact your local dealer or:



Ham Radio Outlet (HRO)
www.hamradio.com

Western US/Canada
Tel: 1-800-854-6046

Mountain/Central
Tel: 1-800-444-9476

Southeast
Tel: 1-800-444-7927

Mid-Atlantic
Tel: 1-800-444-4799

New England/Eastern Canada
Tel: 1-800-444-0047

Northeast
Tel: 1-800-644-4476



Amateur Electronic Supply (AES)
www.aesham.com

Milwaukee, WI
Phone: 1-800-558-0411

Cleveland, OH
Phone: 1-800-321-3594

Las Vegas, NV
Phone: 1-800-634-6227

Orlando, FL
Phone: 1-800-327-1917

Ham Radio Outlet (HRO)
www.hamradio.com