

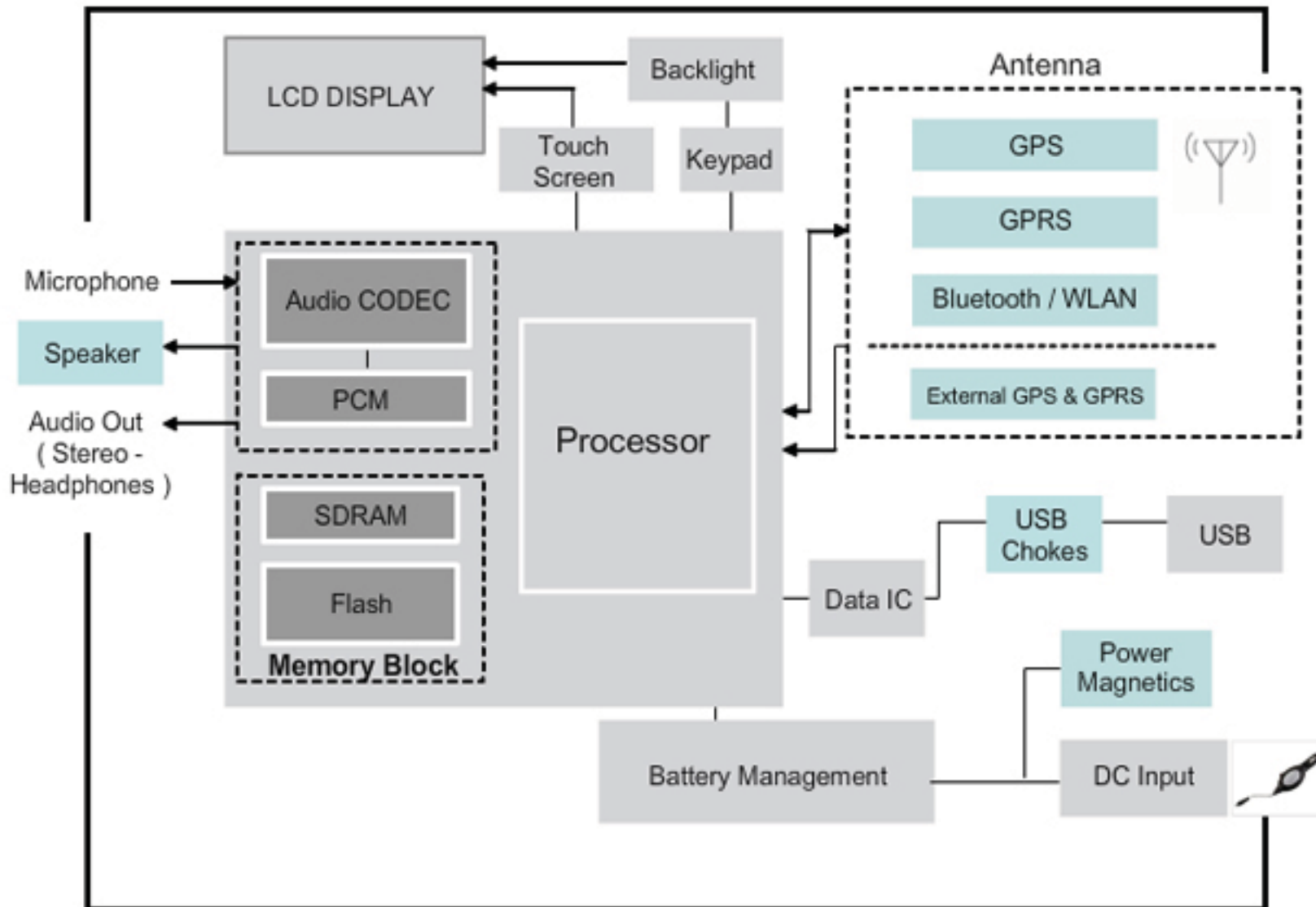

Portable Navigation Device (PND)

The Pulse efficient display monitoring solution

Portable Navigation Devices (PNDs) are a key part of today's most useful, most efficient monitoring solutions. Walk through the storm, walk through the darkness of night, walk through the howling wind, walk through a perilous fight. With Pulse, you never walk alone.



Close

Speakers



Loud Speakers

Our product range comprises high quality receivers and speakers. Our innovative product portfolio is a result of on-going, intensive research and development. Key market drivers push for ever smaller size, increasing quality, cost competitiveness and higher performance.

Click the image to view products from the Audio

Close

GPS Antenna



Internal antenna

Ex

GPRS Antenna

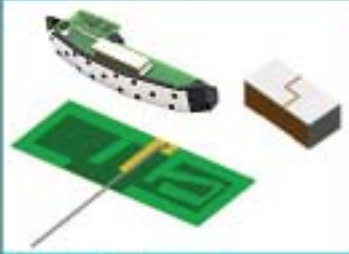

Internal antenna

Ex

GPS/GPRS Combo



External Antenna

Antenna products designed to operate at 1.575MHz frequency and provide connection with the GPS Satellites for navigation and tracking applications. Pulse provides Internal Antennas which are small form factor which can be mounted direct to the PCB while still providing high performance for fast first fixes to the satellites.

Pulse also provide active antenna for connection to the PND or PDA via an external connector on the product. These booster or high performance peripheral antenna can be available in IP6X options

Microph
Speak
Audio C
(Stere
Headph

Backlight

Antenna



Close

GPS Antenna

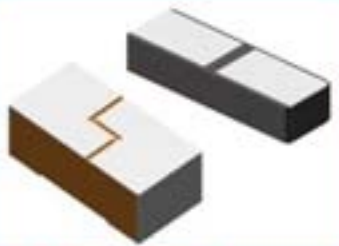

Internal antenna



External Antenna

GPRS Antenna

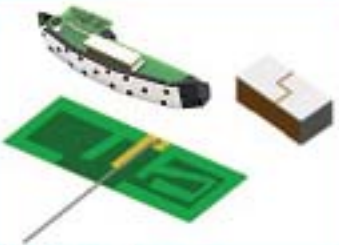

Internal antenna



External Antenna

GPS/GPRS Combo



External Antenna

Antenna products designed to operate at 1.575MHz frequency and provide connection with the GPS Satellites for navigation and tracking applications. Pulse provides Internal Antennas which are small form factor which can be mounted direct to the PCB while still providing high performance for fast first fixes to the satellites. Pulse also provide active antenna for connection to the PND or PDA via an external connector on the product. These booster or high performance peripheral antenna can be available in IP6X options

Close

GPS Antenna

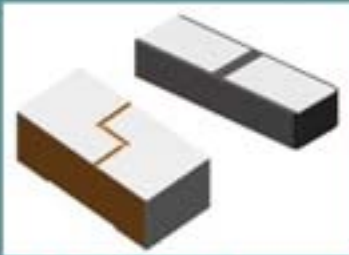

Internal antenna

Ext

Designed for all Cellular frequencies providing Omnidirectional radiation pattern. Exceptional performance is delivered to provide reliable on line download of information

GPRS Antenna

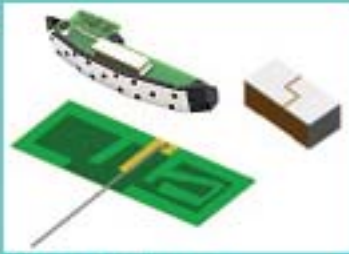

Internal antenna

Ext

Pulse provide Internal antenna with compact form factors enabling direct connection to the PCB. Available in a variety of options such as ceramic, PCB, hybrid configurations. Custom solutions available on request, contact your local representative for details

GPS/GPRS Combo



External Antenna

External Antenna solutions are available which connect via an external RF port on the PND to provide the option of a high performance peripheral or boost antenna.

Close

GPS Antenna

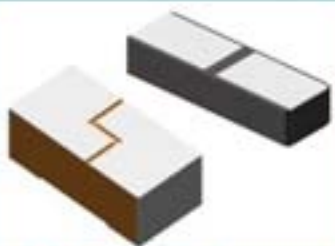

Internal antenna



External Antenna

Designed for all Cellular frequencies providing Omnidirectional radiation pattern. Exceptional performance is delivered to provide reliable on line download of information

GPRS Antenna

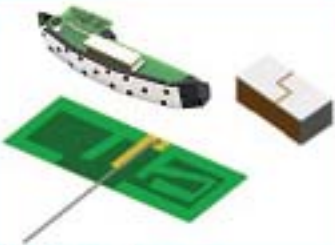

Internal antenna



External Antenna

Pulse provide Internal antenna with compact form factors enabling direct connection to the PCB. Available in a variety of options such as ceramic, PCB, hybrid configurations. Custom solutions available on request, contact your local representative for details

GPS/GPRS Combo



External Antenna

External Antenna solutions are available which connect via an external RF port on the PND to provide the option of a high performance peripheral or boost antenna.

Close

GPS Antenna

Designed for all Cellular frequencies providing Omnidirectional radiation pattern. Exceptional performance is delivered to provide reliable on line download of information

GPRS Antenna

Pulse provide Internal antenna with compact form factors enabling direct connection to the PCB. Available in a variety of options such as ceramic, PCB, hybrid configurations. Custom solutions available on request, contact your local representative for details

GPS/GPRS Antenna

External Antenna solutions are available which connect via an external RF port on the PND to provide the option of a high performance peripheral or boost antenna.

External Antenna

Antenna

Outdoor Antenna

Microph

Speak

Audio C
(Stere
Headph



Close

Antenna

GPS Antenna

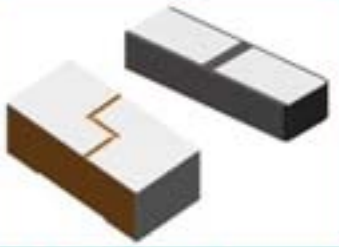

Internal antenna

Ext

GPRS Antenna

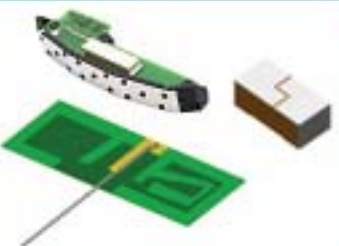

Internal antenna

Ext

GPS/GPRS Combo



External Antenna

Antenna products designed to provide connection to Multiband Cellular frequencies and the 1.575MHz GPS band with one antenna. Antenna solutions provide connection to the GPS Satellites for location information and transmit this data to the monitoring station or tracking system via the cellular network. These booster or high performance peripheral antennas are available in IP6X options.

Backlight

Microph

Speak

Audio C
(Stere
Headph

B



X Close

Antenna

Backlight

Bluetooth / WLAN and Other Antenna

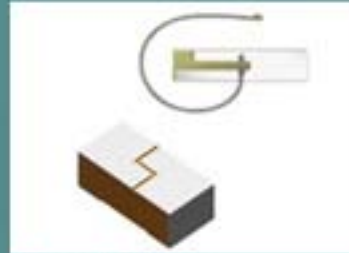

Internal antenna



Other Antenna

Designed for Bluetooth and WLAN applications providing Omnidirectional radiation pattern providing 360° coverage. Pulse antennas provide excellent performance in small board space area and compact form factors providing efficient embedded solutions for PND applications.

Pulse offers many other Antenna options. To link to the applications site for all



X Close

USB Chokes



Common Mode
Chip Choke



Chip Inductors



Chip Inductor
Sample kit

Pulse offers a wide range of wire wound chip choke components specifically design to suppress noise generated within the USB interface.

The 0402 to 1206 chip inductor and USB chip choke series of *Miniature RF Inductors* all contain wire wound technology based on a ceramic or ferrite core. These Inductors feature high Qs and SRFs and an industry standard size and foot print. Tighter inductance tolerances are available from 1 to 10% and are available in Tin or Gold termination finishes. All parts are RoHS compliant. Sample kits are available from Pulse for all series.

X Close

Backlight

Antenna

Power Magnetics



SMT Unshielded Drum Core Inductors



SMT shielded Drum Core Inductors



1008CQ High Q Inductors

Pulse offers a range of surface mount (SMT) and through hole (THT) shielded and unshielded drum core inductors, coupled toroid inductors and common mode chokes.

The components are designed to produce low radio frequency emissions (toroid inductors), support ruggedized header construction for industrial/aerospace type applications (typically THT type), are available in tape and reel (T&R) SMT package type components, current rating to 38 Amps, dielectric strength 1000VRMS, voltage rating to 250VA and available in a variety of inductance values from 1.1 μ H to 439 μ H.